



PROJECT

CATALOG #

TYPE

NOTES

PB Up Light DESIGNER PLUS

Medium-sized wall wash light in 1 or 3 LED. Available in brass construction. RGBW capable with Luxor® ZDC systems.

Quick Facts

- Brass construction
- Natural or antique brass finishes
- Cree® integrated LEDs
- ProAim™ adjustability
- Tamper-resistant features
- Color temperature filters
- Compatible with Luxor technology
- Phase and PWM dimmable
- Input voltage: 10-15V

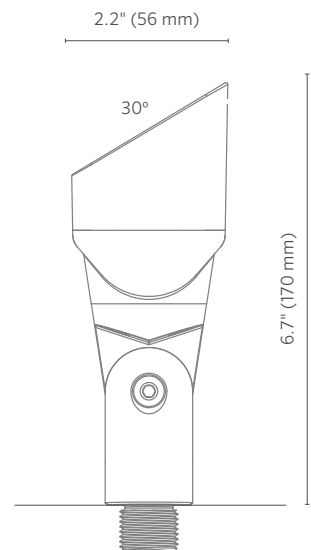

PB Up Light SPECIFICATIONS

Output	1LED	3LED	3LEDT	ZDC
Total Lumens†	67	160	146	122
Input Voltage	10 to 15V	10 to 15V	10 to 15V	11 to 15V
Input Power (W)	2.0	4.2	4.2	6.0
VA	2.4	4.5	4.5	7.2
Efficacy (Lumens/Watt)	34	39	42	37
Color Rendering Index (CRI)	83	82	--	83
Center Beam Candlepower	37	93	304	122
Dimming	PWM, Phase**	PWM, Phase**	PWM, Phase**	--
RGBW Available	No	No	No	Yes
Luxor Compatibility				
Default	Zoning	Zoning	--	--
ZD Option	Zoning/Dimming	Zoning/Dimming	Zoning/Dimming	--
ZDC Option	--	--	--	Zoning/Dimming/Color
Minimum Rated Life (L70)	50,000 Hrs	50,000 Hrs	50,000 Hrs	50,000 Hrs

** For optimal performance, use a trailing-edge, phase-cut dimmer.

† Measured using the 3,900K CCT lens. Multipliers for other CCTs include 0.80 (2,700K), 0.65 (4,500K), and 0.65 (5,200K).

FX Luminaire

FX Luminaire is an industry-leading manufacturer of landscape and architectural lighting products with a focus on the advancement of LED technology and digital lighting control with zoning, dimming, and color adjustment capabilities. We offer a full spectrum of highly efficient lighting fixtures that can be utilized to create elegant, cutting-edge landscape lighting systems for commercial or residential applications. Our products are available exclusively via our extensive professional distributor network.

Materials

Die-cast C360 brass housing, shroud, and knuckle/base assembly with brass hardware.

Socket

Socket contains MoistureBlock™ technology, preventing moisture from wicking up into sealed areas of the fixture.

Lamp

Integrated module with Cree LEDs. Gold-plated connectors and conformal coated for maximum reliability and corrosion resistance. Proprietary on-board intelligent driver uses firmware-controlled temperature regulation, maximizing LED life. Field upgradeable and replaceable, the LEDs are rated to 50,000 hrs. Maximum drive current: 1 A.

Optics

Polycarbonate color temperature adjustment lenses included with fixture: 2,700K (preinstalled), 3,900K (no lens), 4,500K, and 5,200K. Color temperature lenses field serviceable. Beam angle is calculated using LM-79 method for SSL luminaires.

Wiring

18 AWG (1 mm); SPT-1W; 220°F (105°C); 300V; 10' (3 m) length.

Shroud

Die-cast brass shroud with 30° cutoff.

Power

Input 10-15VAC/VDC 50/60Hz. Remote transformer required (specify separately).

Housing

Die-cast brass housing with capacity for 1LED, 3LED, or ZDC integrated LEDs.

Knuckle

Die-cast brass knuckle with ½"-14 (13 mm) NPSM threads. Compress and lock features prevent slip after installation. 9° increments adjustability over 220° of vertical adjustment.

Lens

Tempered frosted glass lens with shock resistance and high tolerance for thermal expansion and stress.

Finish

Options of natural brass finish, or antiqued finish with brushed (Antique Bronze) or tumbled (Antique Tumbled) effect. Antique finishes sealed with a clear TGIC powder coat layer.

Hardware

Brass angle lock screw with setscrew. Includes ProAim ratcheting ABS spike for 360° horizontal rotation in 10° increments. Tamper-resistant locking screw included.

Ambient Operating Temperature

0°F to 140°F (-18°C to 60°C)

Weight

2.4 lbs. (1.1 kg)

Control

ZD or ZDC options utilize Luxor technology to zone light fixtures in up to 250 groups, dim each group in 1% increments between 0 and 100%, or change to one of 30,000 colors with RGBW LEDs. Select the ZD option for zoning/dimming or ZDC for zoning/dimming/color. Standard fixture is zoneable with Luxor.

Installation Requirements

Designed for installation in the upward direction only.

Manufacturing

ISO 9001:2015 certified facility

Wildlife-Friendly Lighting

Available with wildlife-friendly amber LEDs.

International Compliance

Compliant per IEC 60598-1 and IEC 60598-2-7 when used with ground mount ("GM-XX") accessory, or alternate mount greater than or equal to IP65, or by selecting the "e" version.

Sustainability

Innovation meets conservation in the design and manufacturing of our products. Where we can, we use recycled materials while maintaining superior functionality. Our LED products provide high-quality light at optimal energy efficiency, lifespan, and durability.













Warranty

10-year limited warranty.

Listings



PB Up Light ORDERING INFORMATION

Fixture	Luxor Option	Output	Compliance	Finish
PB*	[default] Zone	1LED 67 Lumens	[default] ½" (13 mm) Thread UL-Listed	BS Natural Brass  WG White Gloss 
	ZD Zone/Dim	3LED 160 Lumens	e Bracket Mount CE Approved	BZ Bronze Metallic  FW Flat White 
		3LED** Wildlife-Friendly Amber (585-595 nm)		DG Desert Granite  AL Almond 
	ZDC Zone/Dim/Color	[default] 122 Lumens		WI Weathered Iron  AB Antique Bronze 
			SB Sedona Brown  AT Antique Tumbled 	
			FB Black  NP Nickel Plate 	









EXAMPLE FIXTURE CONFIGURATION: PB-ZD-1LED-AT





* Ships with ProAim ratcheting spike

** Available with ZD Luxor option and BS, AB, AT, or NP finishes only.

MOUNTING OPTIONS: Specify Separately

Mounts	Code	
■ SUPER J-BOX 2.5" (64 mm) x 12" (305 mm)	SJ-XX*	
■ POST MOUNT 2.5" (64 mm) x 13" (330 mm)	PM-XX*	
■ GROUND MOUNT 2.7" (67 mm) Diameter	GM-XX*	
■ VERSABOX® 2.2" (57 mm) x 1.5" (39 mm)	VB-050-XX*	
■ GUTTER MOUNT 4.0" (102 mm) x 4.0" (102 mm)	GM-SS	
■ MINI J-BOX 3.5" (89 mm) x 1.3" (34 mm)	MJ-050-XX*	
■ TREE BOX 5.4" (138 mm) x 1.9" (49 mm)	TB-XX*	
■ WALL PLATE: Round 5.0" (127 mm) Diameter	WP-RD-050-XX*	

COUPLING OPTIONS: Specify Separately

Couplings	Code	
■ STRAIGHT 1.3" (32 mm) x 2.0" (51 mm)	COUP-XX*	
■ 90° ELBOW 1.3" (32 mm) x 2.0" (51 mm)	ELBW-050-XX*	
■ T-MOUNT 3.0" (76 mm) x 2.2" (57 mm)	TMNT-050-XX*	

RISER OPTIONS: Specify Separately

Riser	Code	
■ RISER 1.0" (25 mm) Diameter	YY-R-GT-XX*	

*YY = riser height in inches (6" increments between 6" and 36"; 150 mm increments between 150 mm and 900 mm), XX = finish code

PB 1LED Illuminance at a Distance

Feet (Meters)	Center Beam	Beam Width	
	Foot-Candle (Lux)	Vertical 73.3°	Horizontal 95.6°
4' (1.2 m)	2 fc (25 lx)	6' (1.8 m)	9' (2.7 m)
8' (2.4 m)	0.6 fc (7 lx)	12' (3.6 m)	18' (5.4 m)
12' (3.7 m)	0.2 fc (2 lx)	18' (5.4 m)	27' (8.1 m)
16' (4.9 m)	0.1 fc (1 lx)	24' (7.3 m)	35' (10.8 m)
20' (6.1 m)	0.1 fc (1 lx)	30' (9.1 m)	44' (13.4 m)
24' (7.3 m)	0.1 fc (1 lx)	36' (10.9 m)	53' (16.1 m)

PB 3LED Illuminance at a Distance

Feet (Meters)	Center Beam	Beam Width	
	Foot-Candle (Lux)	Vertical 69.4°	Horizontal 93.0°
4' (1.2 m)	6 fc (62 lx)	6' (1.7 m)	8' (2.6 m)
8' (2.4 m)	1.5 fc (16 lx)	11' (3.4 m)	17' (5.2 m)
12' (3.7 m)	0.7 fc (8 lx)	17' (5.0 m)	25' (7.7 m)
16' (4.9 m)	0.4 fc (4 lx)	22' (6.8 m)	34' (10.3 m)
20' (6.1 m)	0.2 fc (2 lx)	28' (8.4 m)	42' (12.9 m)
24' (7.3 m)	0.2 fc (2 lx)	33' (10.1 m)	51' (15.4 m)

PB 3LEDT Illuminance at a Distance

Feet (Meters)	Center Beam	Beam Width	
	Foot-Candle (Lux)	Vertical 29.2°	Horizontal 30.30°
4' (1.2 m)	19 fc (203 lx)	2' (0.6 m)	2.2' (0.7 m)
8' (2.4 m)	5 fc (60 lx)	4' (1.3 m)	4.3' (1.3 m)
12' (3.7 m)	2 fc (23 lx)	6' (1.9 m)	6.5' (2.0 m)
16' (4.9 m)	1.2 fc (13 lx)	8' (2.5 m)	8.7' (2.7 m)
20' (6.1 m)	0.8 fc (9 lx)	10' (3.2 m)	10.8' (3.3 m)
24' (7.3 m)	0.5 fc (5 lx)	13' (3.9 m)	13' (3.9 m)

PB zDC Illuminance at a Distance

Feet (Meters)	Center Beam	Beam Width	
	Foot-Candle (Lux)	Vertical 52.3°	Horizontal 54.1°
4' (1.2 m)	7.6 fc (82 lx)	4' (1.2 m)	4' (1.3 m)
8' (2.4 m)	1.9 fc (21 lx)	8' (2.4 m)	8' (2.5 m)
12' (3.7 m)	0.9 fc (10 lx)	12' (3.6 m)	12' (3.8 m)
16' (4.9 m)	0.5 fc (5 lx)	16' (4.8 m)	16' (5.0 m)
20' (6.1 m)	0.3 fc (3 lx)	20' (6.0 m)	20' (6.2 m)
24' (7.3 m)	0.2 fc (2 lx)	24' (7.2 m)	25' (7.5 m)